



# CORNICI DECORATIVE IN ESTRUSO



Cornici decorative in polistirene estruso bianco per pareti e soffitti.  
Ideale per la decorazione di qualsiasi ambiente per un effetto gradevole ed elegante.  
Polistirene Classe E.

Polystyrene frames for interior.

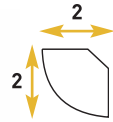

**A 20**



**B 25**

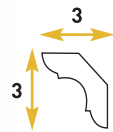

**C 30**

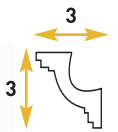

**O 30**

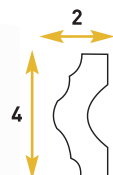

**D 40**



**R 60**

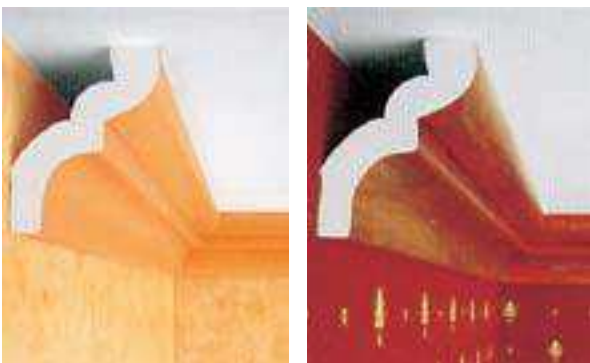

- Ideale per la decorazione di interni
- La lunghezza delle cornici è di cm 200
- Aiutano a creare un ambiente gradevole ed elegante
- Verniciabili con idropitture
- Le istruzioni di posa e la scheda tecnica sono consultabili a fine catalogo
- Misure espresse in centimetri

● ○ ○ **CORNICI** IN POLISTIRENE ESTRUSO BIANCO



- **Angolo universale "duo corner"**
- Disponibile per vari modelli di cornici
- Angoli interni ed esterni con un solo kit



● ○ ○ **CORNICI** IN POLISTIRENE ESTRUSO BIANCO

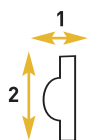

**D 20**

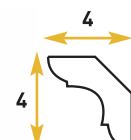

**C 40**



**O 45**

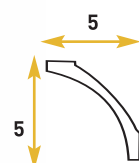

**Z 50**

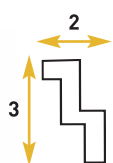

**P 30**

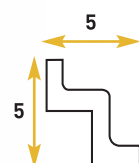

**P 50**

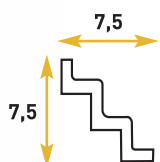

**P 75**



Cornice W70+D40

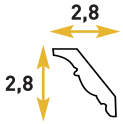

DM 281

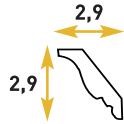

DM 291



DM 352

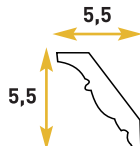

DM 551



DM 552

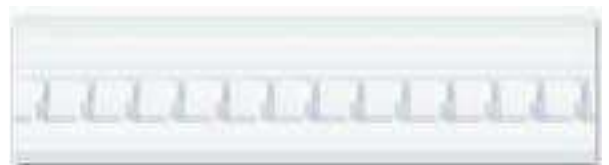

DM 601

- La lunghezza delle cornici è di cm 200
- Verniciabili con idropitture
- La posa in opera risulta facile e rapida grazie all'utilizzo del collante GET - KOL
- Misure espresse in centimetri



DM601+D40

Cornice G300



# CORNICI GESSATE E CLASSICHE



Cornici per rifinitura soffitti. Una vasta scelta di modelli per abbinamenti classici o moderni.

Cornici in polistirene gessato ottenute con finitura liscia e sagomate per:

Gusci - Portaluze - Fasce

Cornici Classiche con disegni stilizzati disponibili sia Gessate che Anticate.

Polistirene Classe E

Decorative polystyrene mouldings.

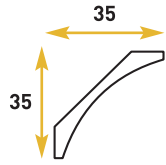

**G 35**

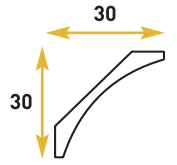

**G 30**

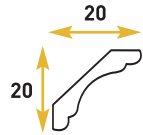

**G 200**

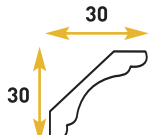

**G 300**

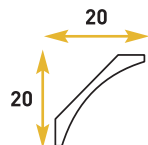

**G 20**

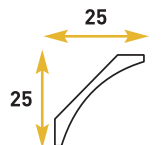

**G 25**

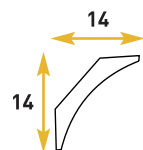

**G 14**

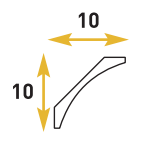

**G 10x10**

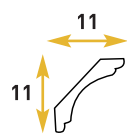

**G 100**

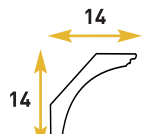

**G 120**



● ○ ○ **CORNICI** IN POLISTIRENE GESSATO BIANCO

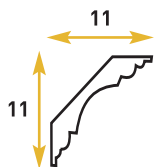

**G 101**

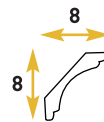

**G 80**

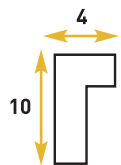

**L 10**

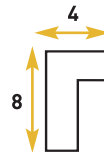

**L 8**

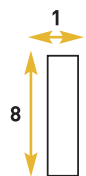

**P 8**

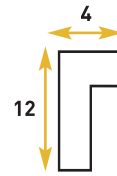

**L 12**



**P 12**

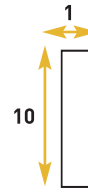

**P 10**

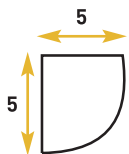

**QT 5**



**P 14**

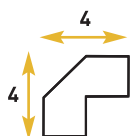

SCAL 4

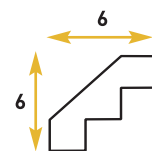

SCAL 6

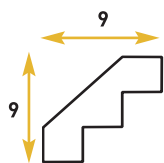

SCAL 9

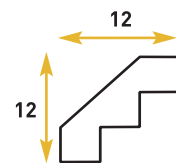

SCAL 12

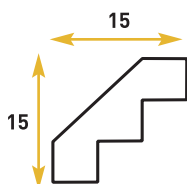

SCAL 15

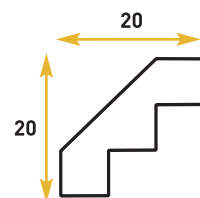

SCAL 20

- Ideale per la decorazione di soffitti e pareti
- La lunghezza delle cornici è di cm 200
- Realizzabili anche su progetto
- Verniciabili con idropittura
- Le istruzioni di posa e la scheda tecnica sono consultabili a fine catalogo
- Misure espresse in centimetri



Cornice G100

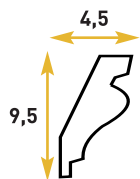

**E 95**

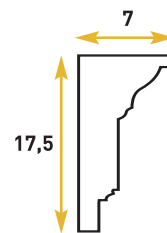

**G 18**



**E 65**

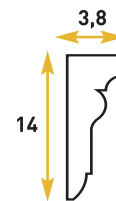

**E 14**

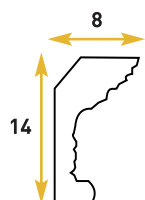

**145 - 3**



**E 70**

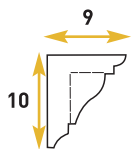

**CASTELLO GESSATO**

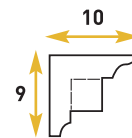

**TORRE GESSATO**

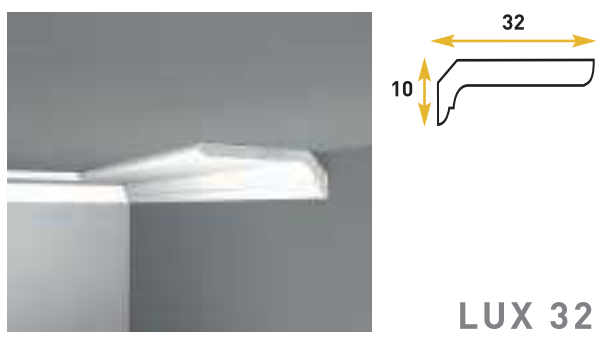
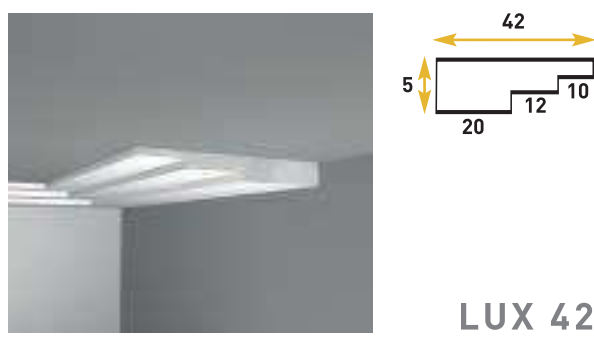
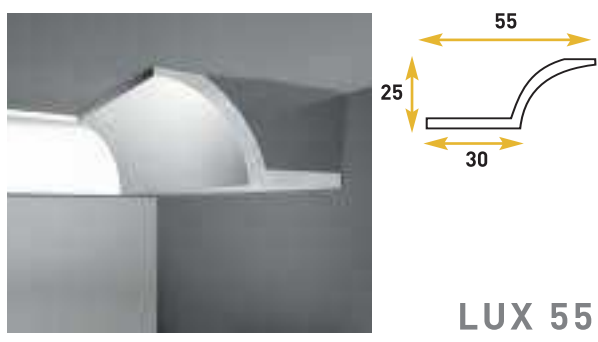
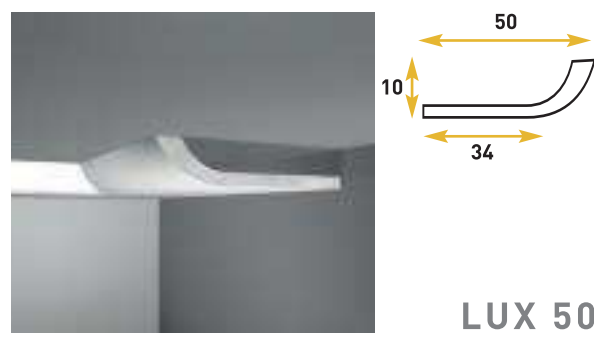
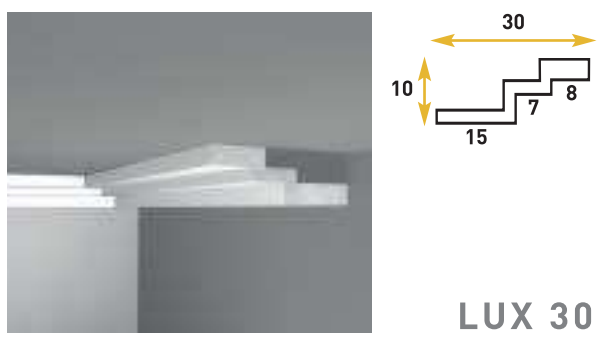
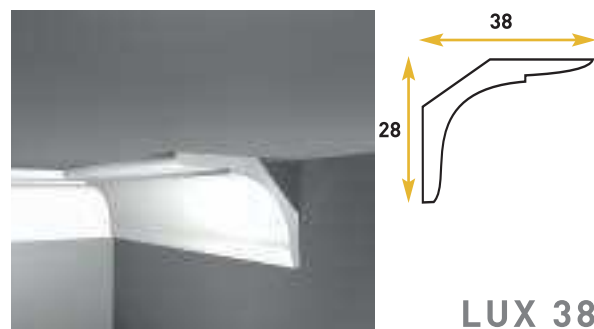
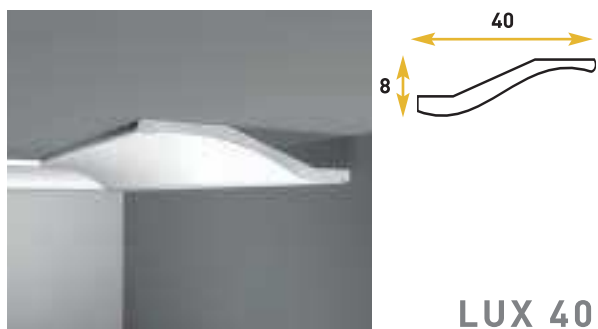

- Cornici ad effetto volume per ambienti moderni
- Si considerano anche sagome a richiesta su misura
- La lunghezza delle cornici è di cm 200
- Verniciabili con idropitture