

ESTERNI



ELEMENTI DECORATIVI PER ESTERNI

Siamo presenti da oltre 25 anni con una produzione continua di Elementi Decorativi per Facciate. Un'esperienza unica nel settore. Valorizzare al meglio ogni vostro progetto è il nostro fondamento. Ottenere una raffinata armonia di stili e forme, curando ogni particolare proposto o indicato dal progettista. Il nostro lavoro è basato su una produzione sempre aggiornata secondo le migliori innovazioni tecniche ed eseguita con personale altamente qualificato.

Elementi facili da installare e di grande effetto finale. Possibilità di personalizzare ogni facciata con i modelli da catalogo oppure di richiedere lavorazioni speciali e su progettazione con preventivi immediati e tempi di realizzazione brevi.

Il nostro ufficio tecnico è a vostra disposizione per qualsiasi esigenza.



COMPOSIZIONE BASE:
POLISTIRENE ESPANSO UNI IIP
SINTERIZZATO VERGINE
ALTA DENSITÀ KG.30/MC.
AUTOESTINGUENTE

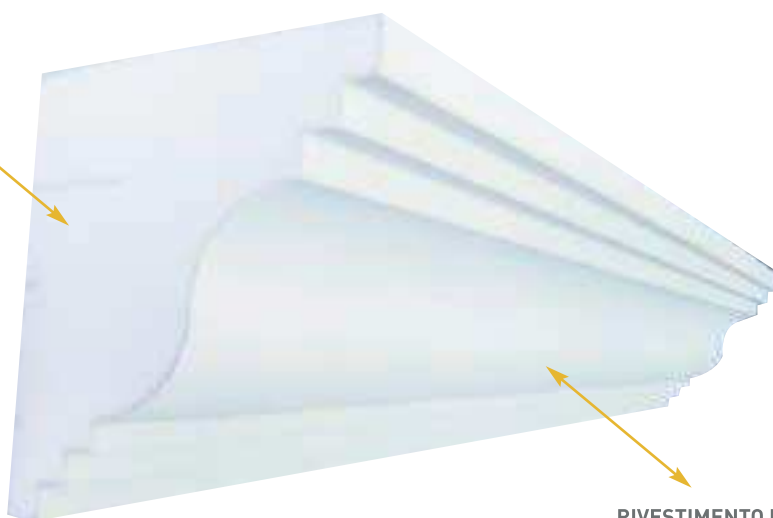

RIVESTIMENTO FINALE:
CON CICLO SPALMATO COMPOSTO DA
GRANIGLIE DI MARMO E SILICIO IN
EMULSIONE CON PREGIATE RESINE

UNA GAMMA COMPLETA PER SODDISFARE OGNI ESIGENZA

Leggerezza: facilità e rapidità di posa

Resistenza: elevata resistenza chimico - fisica agli agenti atmosferici

Flessibilità: gli elementi si adeguano perfettamente ad ogni movimento dei supporti o muri

Creatività: possibilità di eseguire lavori su progetto

Ponti termici: elimina ogni problema di ponte termico grazie alle sue proprietà isolanti

Garanzia: oltre venticinque anni di esperienza nel settore

Disponibilità: oltre cento modelli pronti in deposito

Economicità: prodotto estremamente economico paragonato ad altri materiali

CORNICI MARCAPIANI DECORI

**Le più belle facciate classiche
o moderne rifinite con prodotti Ital Decori**

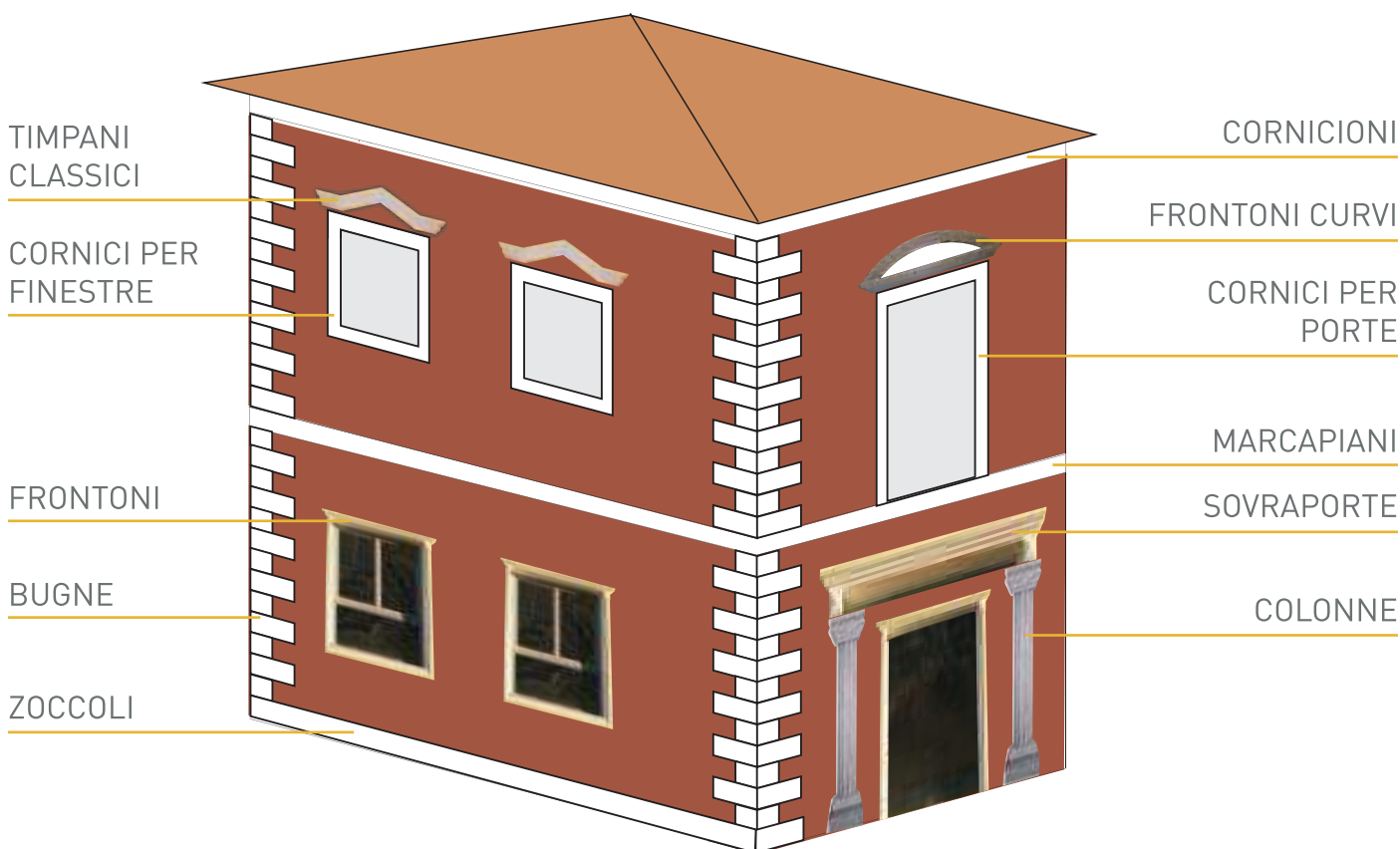

Cornice FR 15
Chiave 20
PIR 15



CORNICI PER PORTE E FINESTRE



Eleganti forme per la finitura di porte e finestre.
Lunghezza delle cornici cm 200.
Verniciabili con idropitture elastomeriche da esterni

Door and window frames for exterior.

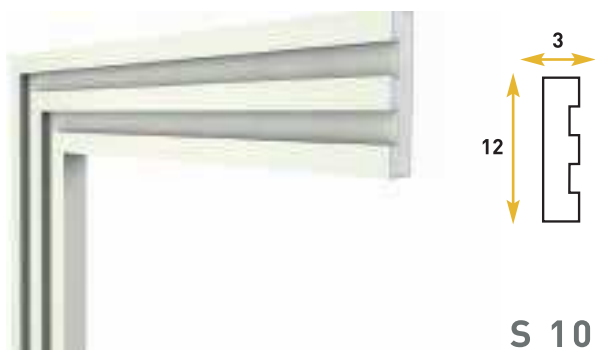

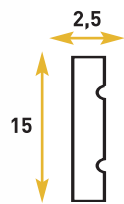

MB 15

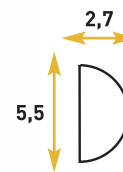

TORO 1

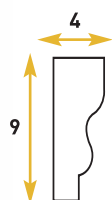

CAP 9



TORO 2

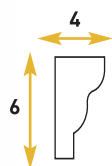

CAP 6



LES 14

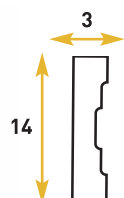

LES BIS

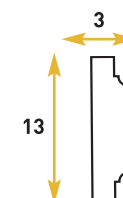

MB 13

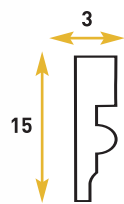

MB 14



MB 17



FB 7

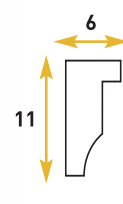

FB 11

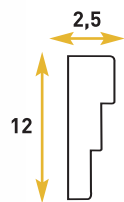

FB 12

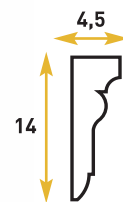

S 14

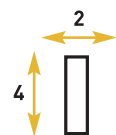

FR 4

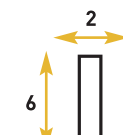

FR 6

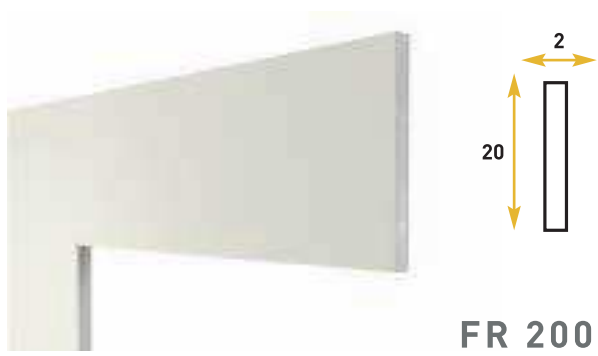

- Le misure sono espresse in centimetri, la lunghezza delle cornici è di cm 200
- Fornite in finitura bianca, verniciabili con idropitture elastomeriche
- Le istruzioni di posa e la scheda tecnica sono consultabili a fine catalogo

Cornice FR 200



Evidenziare ogni particolare per un risultato semplice e raffinato.

Door and window frames for exterior.

CORNICI
E
MARCAPIANI







- La lunghezza delle cornici è di 200 cm
- Disponibile in finitura bianca
- Verniciabili con idropitture elastomeriche
- Le istruzioni di posa e la scheda tecnica sono consultabili a fine catalogo
- Le misure sono espresse in centimetri



Cornici su progetto

Cornice 030

Cornice
FR140 centinata

Cornice MB14

CORNICIONI E SOTTOGRONDA



Valorizzare l'estetica della facciata per distinguersi e ritrovare il giusto stile.

Frames for exterior.

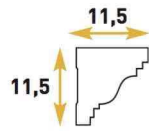

010

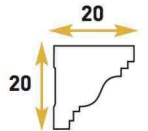

020

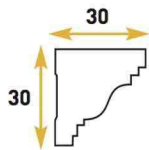
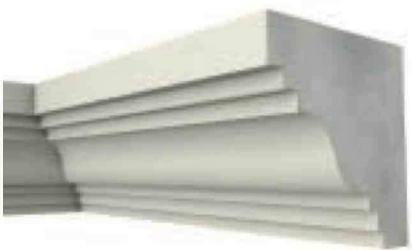

030

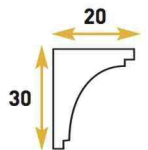
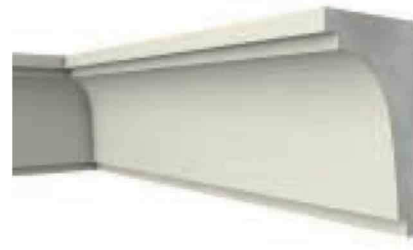

MB 30

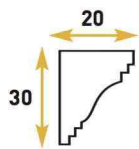

SG 30

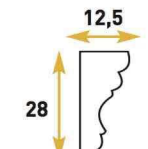

MB 28

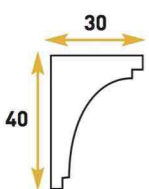

MB 40

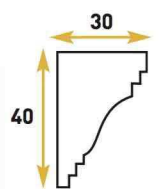
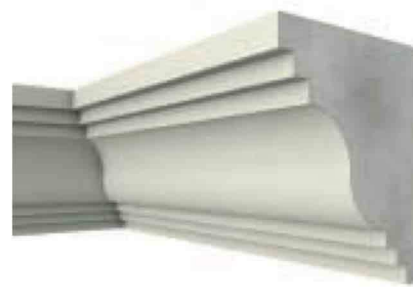

SG 40



FB 40



MB 16



Cornice MB 50
Fase di montaggio



MB 50



MB 27



MB 18



MB 25



Cornice Castel 30



CASTEL 30



CASTEL 20

● ○ ○ CORNICI PER BALCONI E FRONTALINI

ELEMENTI SPECIALI PER FINITURA E PROTEZIONE:

Eccezionale soluzione per proteggere e rifinire balconi e frontalini, è un ottimo isolante resistente agli agenti atmosferici. Elimina i ponti termici, protegge il calcestruzzo a vista. Posa in opera facile e rapida con collante Bonding, verniciabili con idropitture ELASTOMERICHE per esterni. Lunghezza delle cornici cm. 200

Prima



Dopo

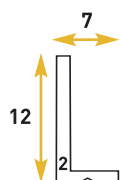
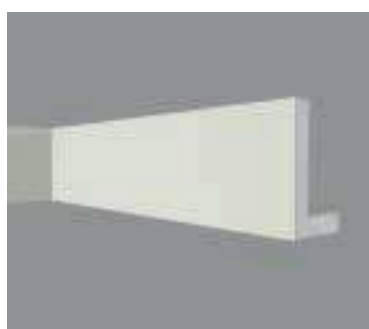
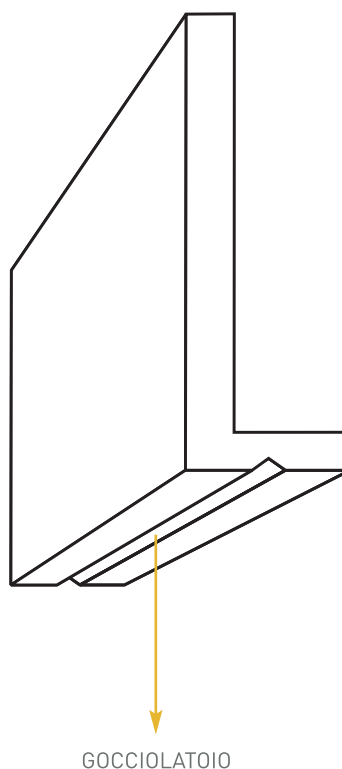

FRONT 12

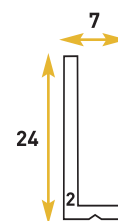

FRONT 24

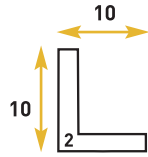
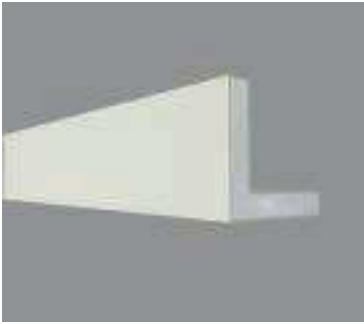

PAR 10

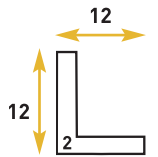
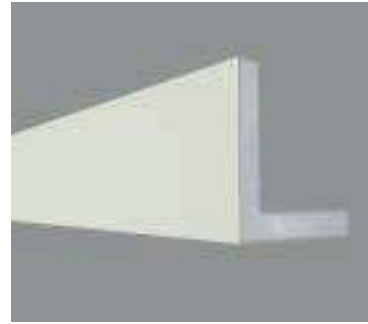

PAR 12

Cornice PAR 20



IDEALI PER PORTE - FINESTRE - SPIGOLI - ANGOLI

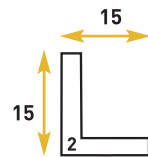
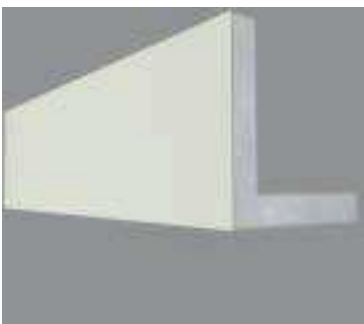

PAR 15

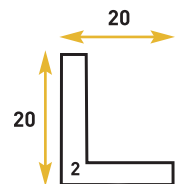
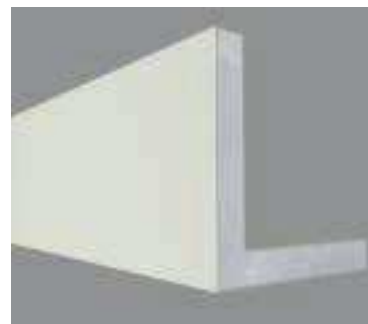

PAR 20



ZOCCOLI E BOISERIE



Importante soluzione per rifinire qualsiasi parte bassa della facciata. Donando un gradevole aspetto finale. Inoltre apporta un'ottima protezione ed isolamento termico.

Skirting for exterior.



ZOCCOLO 1



ZOCCOLO 2



ZOCCOLO 3



ZOCCOLO 30



ZOCCOLO 40



ZOCCOLO 50

- Le misure sono espresse in centimetri, la lunghezza delle cornici è di cm 200
- Disponibile in finitura bianca, verniciabili con idropitture elastomeriche
- Le istruzioni di posa e la scheda tecnica sono consultabili a fine catalogo

● ○ ○ ZOCCOLI



ZOCCOLO 60



ZOCCOLO 70



ZOCCOLO 80



BOISERIE 80



BOISERIE 90



BOISERIE 100



BOISERIE 110

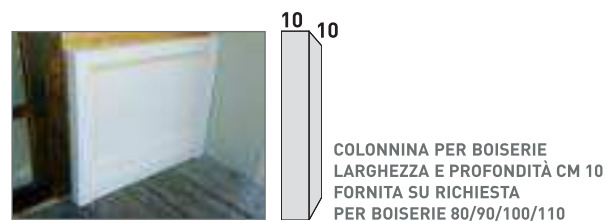

SCHEMA MONTAGGIO BOISERIE+COLONNINA

La Boiserie è fornita in pannelli da cm 100 e lo Zoccolo da cm 200

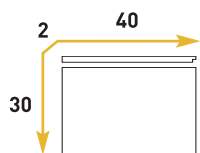

CONCIO 30

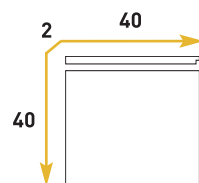

CONCIO 40

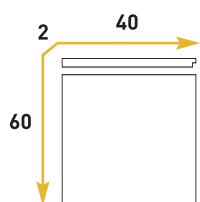

CONCIO 60

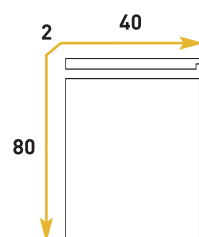

CONCIO 80

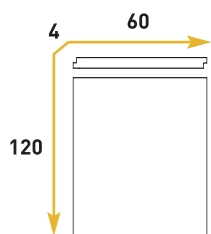

PANNELLO CAPPOTTO



**BATTENTE PER INCASTRO
RIMANENTE FUGA DA cm 1x1 A VISTA**

CONCIO PER ZOCCOLATURE

- Utilizzo specifico per montaggio in serie su parti perimetrali basse
- Ottimo per rifinire e proteggere dall'umidità

PANNELLO CAPPOTTO

- Composizione: EPS 200, con finitura in graniglia bianca
- Fornito pronto per essere posato in opera su pareti di qualsiasi genere
- Applicazione con apposito collante Bonding mediante stesura con spatola dentata su retro
- Verniciabili con idropitture elastomeriche



Facciata rivestita
con Fascia 40

Rivestimento a fasce per la decorazione e l'isolamento termico delle facciate.

Panels for exterior.

FASCE





FASCIA 1



FASCIA 2



FASCIA 30



FASCIA 32



FASCIA 40



COPRIFASCIA 4



ESEMPIO ZOCCOLATURA CON ZOCCOLO E FASCIA 2

- Montaggio orizzontale e verticale
- Isolante termico
- Le misure sono espresse in centimetri
- La lunghezza delle cornici è di cm 200
- Disponibile in finitura bianca
- Verniciabili con idropitture elastomeriche



Facciata rivestita con
Bugna 50x30

BUGNE PER ESTERNI



Elegante facciata rivestita con bugne Ital Decori.
Estetica ed isolamento.
Installazione rapida e semplice.

Stones for exterior.

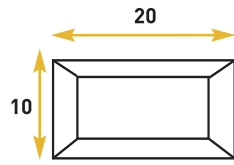

BUGNA 20x10

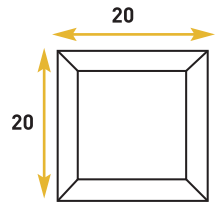

BUGNA 20x20

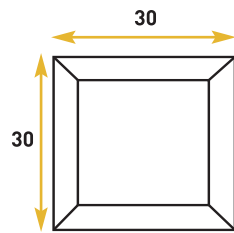

BUGNA 30x30

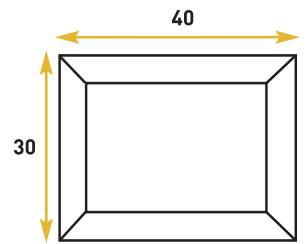

BUGNA 40x30

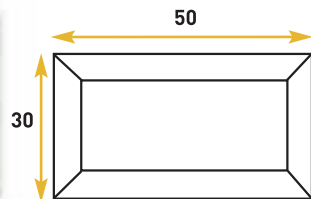

BUGNA 50x30



SEZIONE BUGNE

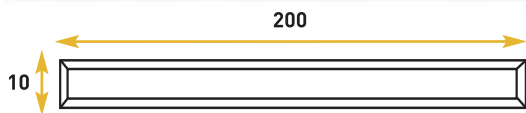

BUGNA 200x10

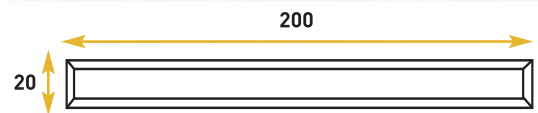

BUGNA 200x20



BUGNA 200x30

- Disponibile in finitura bianca
- Verniciabili con idropitture elastomeriche
- Resistente agli agenti atmosferici
- Posa rapida con collante Bonding
- Le misure sono espresse in centimetri

● ○ ○ **BUGNE PER ESTERNI**

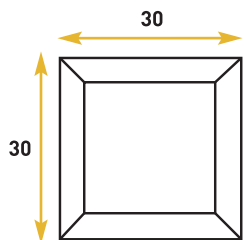

BUGNA ROMANA 30x30

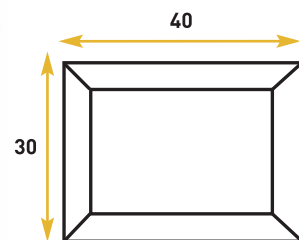

BUGNA ROMANA 40x30

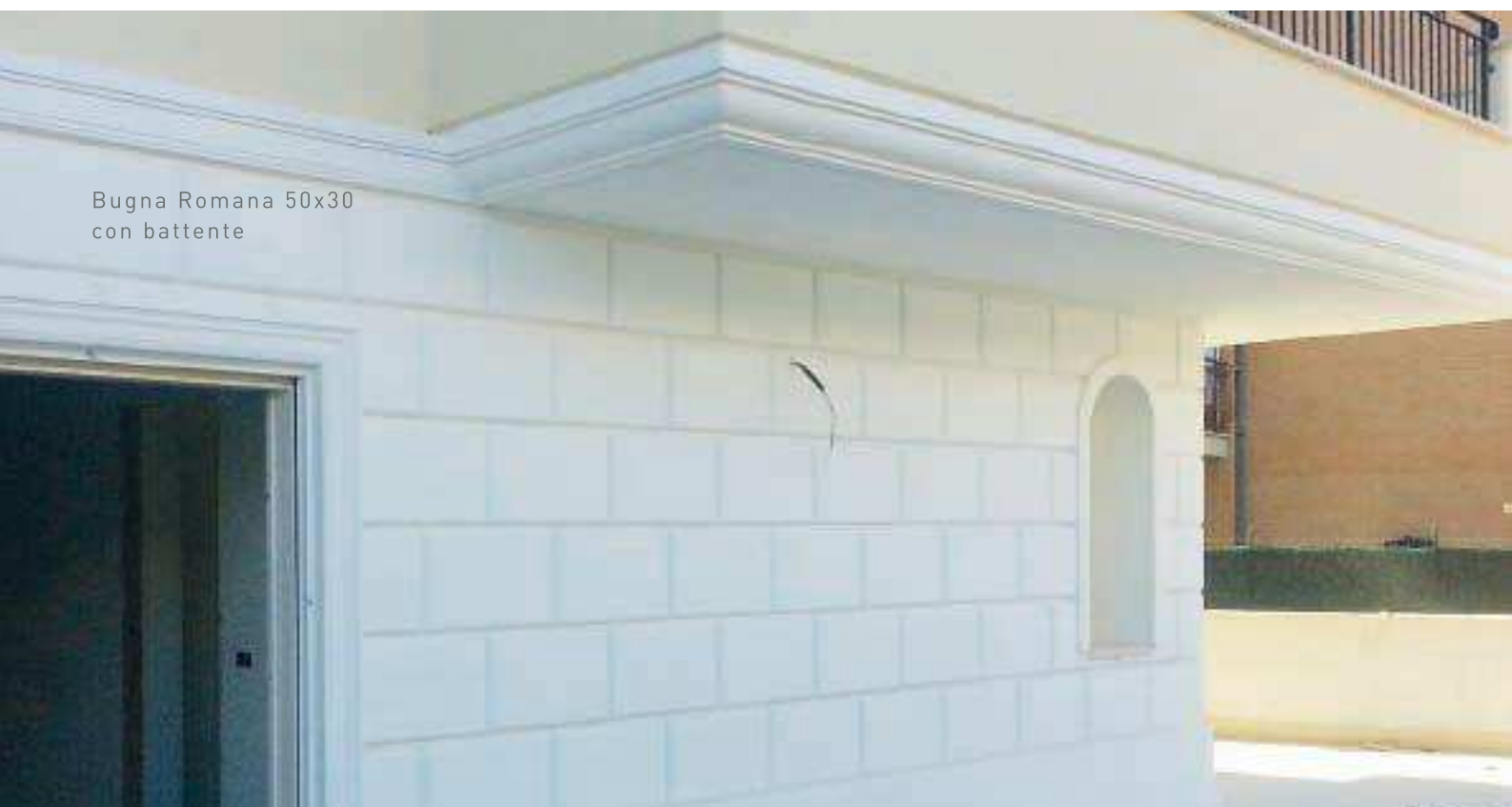

Bugna Romana 50x30
con battente

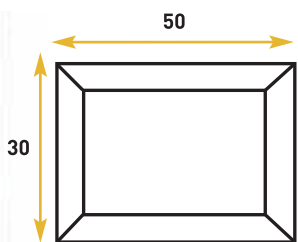

BUGNA ROMANA 50x30

ORDINABILE CON O SENZA BATTENTE
IN BASE ALL'UTILIZZO NECESSARIO



SEZIONE BUGNA ROMANA

Bugna Romana 50x30 e 30x30



COLONNE LESENE ACCESSORI



Colonne - Lesene - Terminali per congiunzioni cornici.
Mensole - Timpani - Frontoni.
Una vasta gamma di decori per impreziosire la
facciata.

Accessoires for exterior.

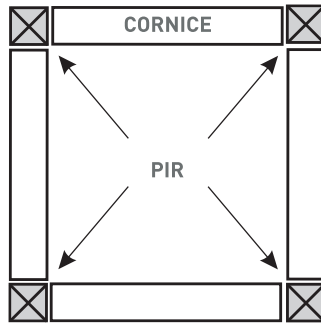

CONGIUNZIONE
PER UNO SQUADRO PERFETTO
ADATTABILI A DIVERSI
MODELLI DI CORNICI

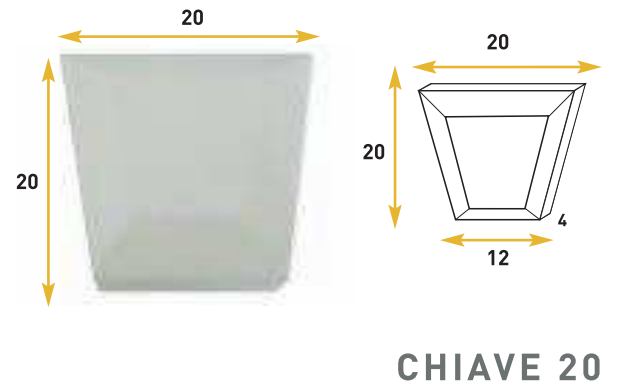
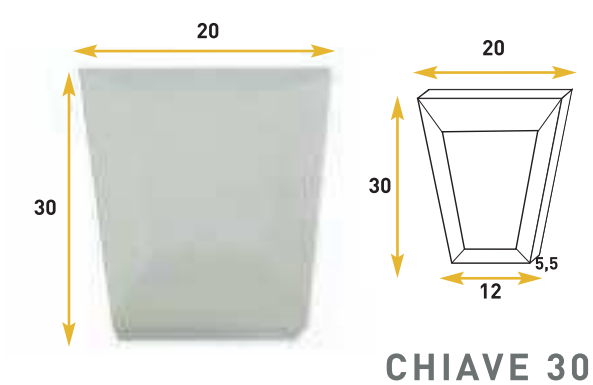
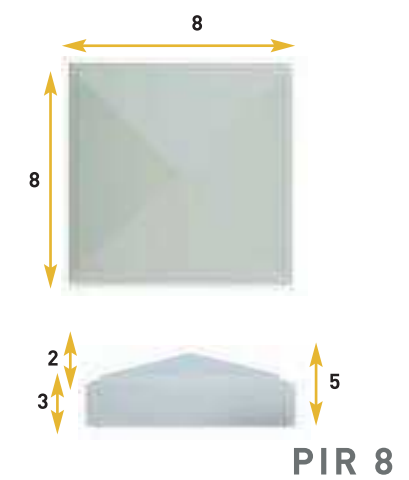
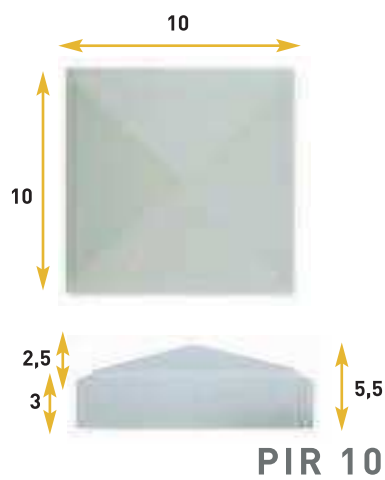
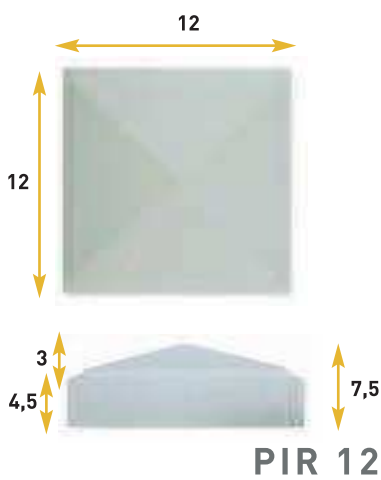
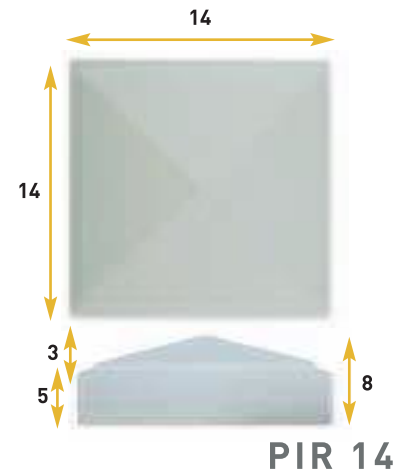
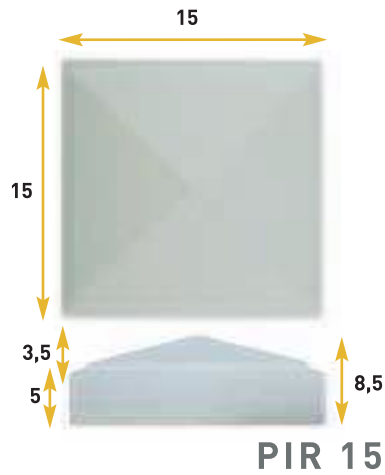
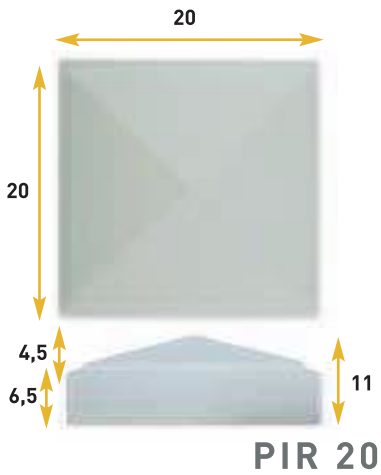

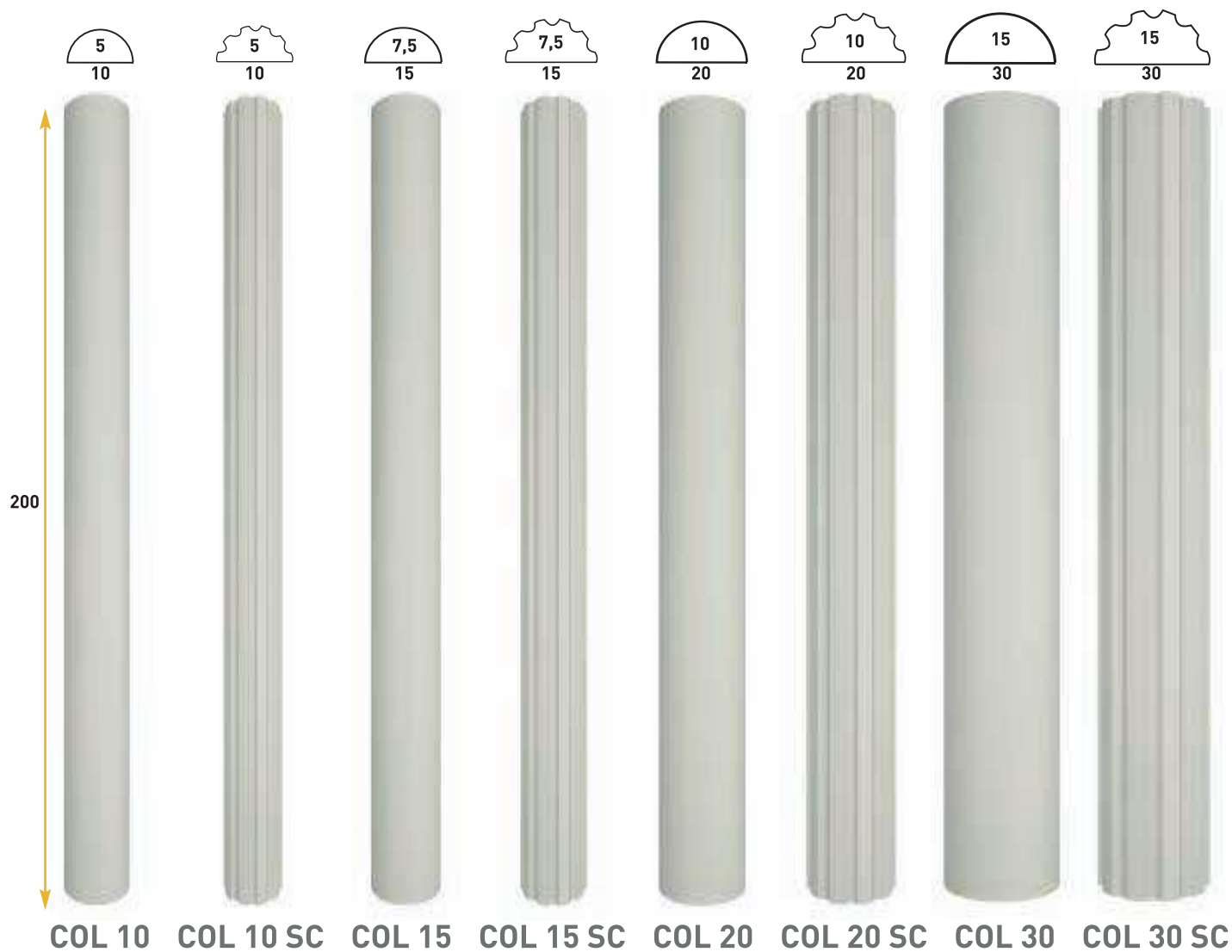

COLONNE, BASI E CAPITELLI POSSONO ESSERE FISSATI DIRETTAMENTE ALLA PARETE MEDIANTE COLLANTE BONDING

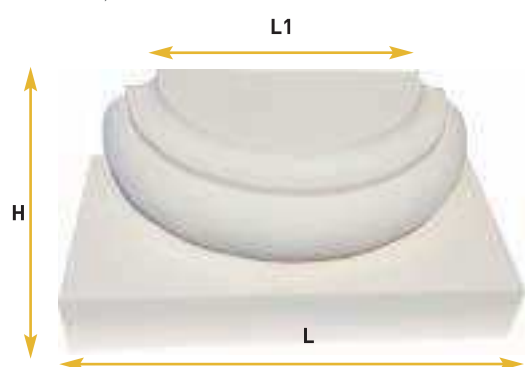

BASE PER COLONNE

BASCOL 10: L=cm17,5 L1=cm11,5 H=cm7
BASCOL 15: L=cm25,5 L1=cm16,5 H=cm10
BASCOL 20: L=cm33,5 L1=cm21,5 H=cm14,5
BASCOL 30: L=cm49,5 L1=cm31,5 H=cm20,5
BASCOL 40: L=cm65,5 L1=cm 41,5 H=cm29



CAPITELLI PER COLONNE

CAPCOL 10: L=cm17,5 L1=cm11,5 H=cm8
CAPCOL 15: L=cm25,5 L1=cm16,5 H=cm11,5
CAPCOL 20: L=cm33,5 L1=cm21,5 H=cm16
CAPCOL 30: L=cm49,5 L1=cm31,5 H=cm22,5
CAPCOL 40: L=cm65,5 L1=cm41,5 H=cm31,5

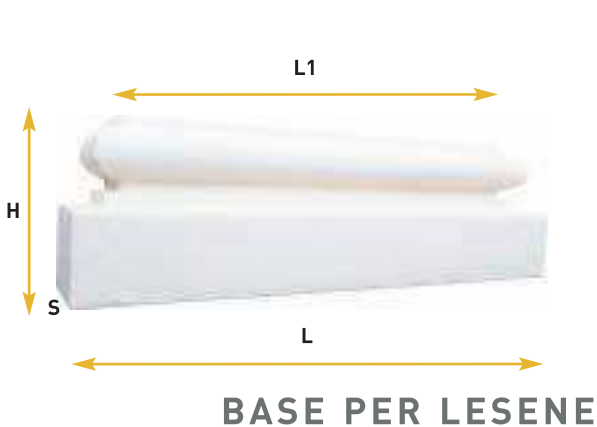
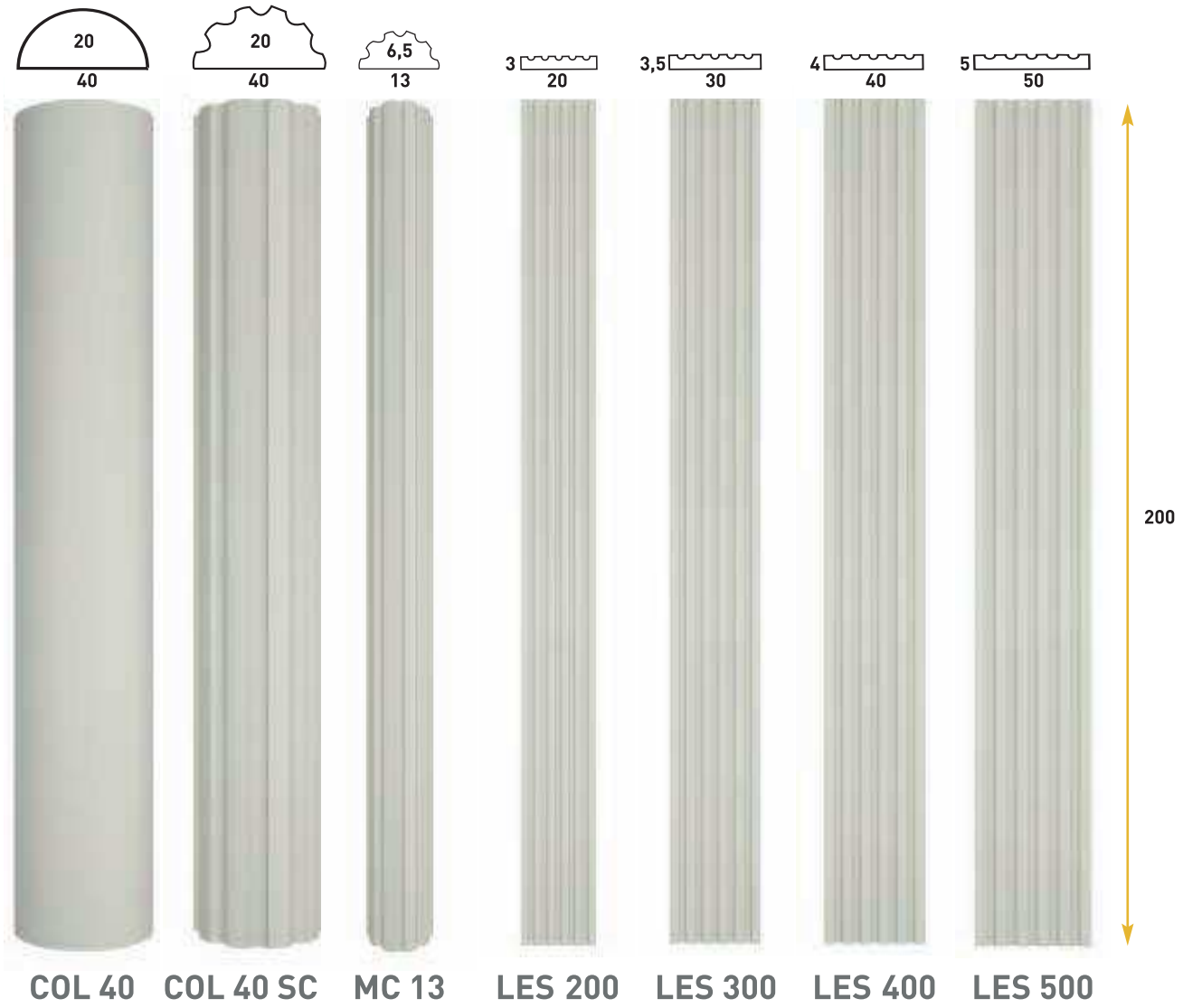

BASE MC13: L=cm21 L1=cm14 H=cm12 S=cm10
BASE LES 200: L=cm28 L1=cm22 H=cm12 S=cm7
BASE LES 300: L=cm38 L1=cm32 H=cm12 S=cm8
BASE LES 400: L=cm48 L1=cm42 H=cm12 S=cm8
BASE LES 500: L=cm58 L1=cm52 H=cm12 S=cm9

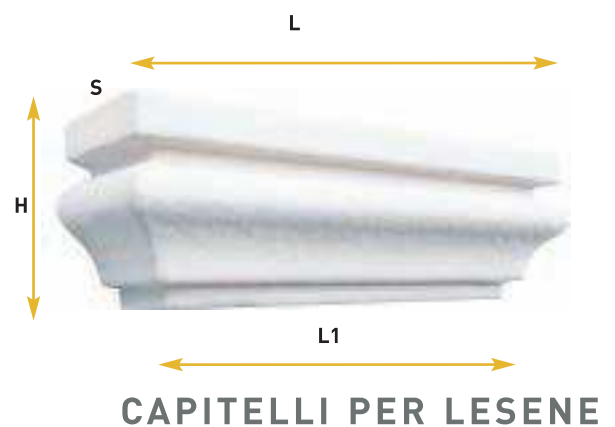

CAPITELLO MC13: L=cm21 L1=cm14 H=cm10 S=cm10
CAPITELLO LES 200: L=cm27 L1=cm22 H=cm10 S=cm6
CAPITELLO LES 300: L=cm37 L1=cm32 H=cm10 S=cm7
CAPITELLO LES 400: L=cm47 L1=cm42 H=cm10 S=cm8
CAPITELLO LES 500: L=cm57 L1=cm52 H=cm10 S=cm9

● ○ ○ **MENSOLE** STAMPATE IN POLIURETANO



K4



K5



Lavorazione eseguita
su progetto



K6



K13

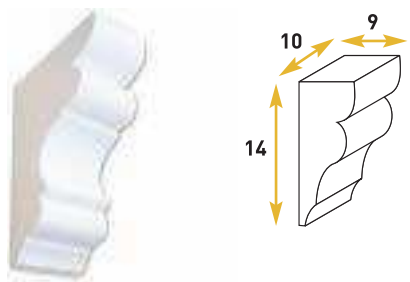

MINI ESTERNO

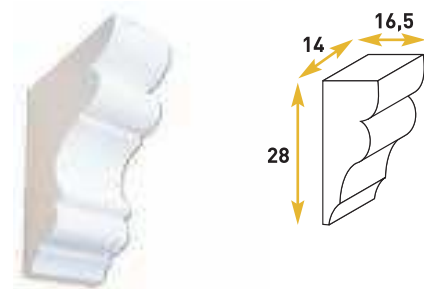

MIDI ESTERNO

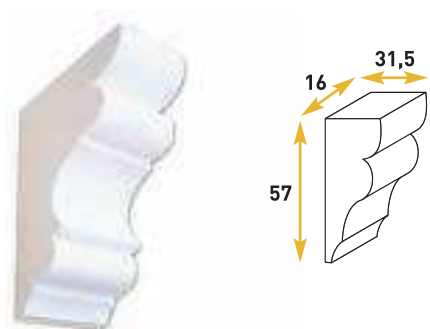

MASTER ESTERNO



GATTONE 1



GATTONE 2



GATTONE 3

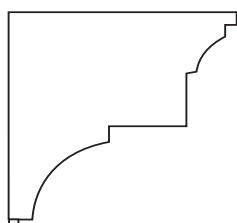

SEZIONE GATTONE

- Disponibile in finitura bianca
- Verniciabili con idropitture elastomeriche
- Resistente agli agenti atmosferici
- Posa rapida con collante Bonding
- Le istruzioni di posa e la scheda tecnica sono consultabili a fine catalogo
- Le misure sono espresse in centimetri



FRONTONE LINEARE

ORDINABILI SU MISURA - ESEMPIO CON CORNICE 020



SOTTOSOGLIA

ORDINABILI SU MISURA - ESEMPIO CON CORNICE 010



SOVRAPORTA PER ESTERNI

ORDINABILI SU MISURA



TIMPANO CLASSICO CM 120xH30

ORDINABILI SU MISURA - ESEMPIO CON CORNICE S101



Lavorazione eseguita
su progetto



FRONTONE CURVO

ORDINABILI SU MISURA - ESEMPIO CON CORNICE 010



Questi decori nobilitano la facciata rendendola elegante ed unica per qualsiasi stile, classico o moderno.

La realizzazione di questi elementi viene supportata dalla possibilità di eseguire su progetto qualsiasi misura.

Inviandoci la vostra richiesta saremo rapidi a fornirvi un preventivo.



BALAUSTRE E COPRIMURO



È possibile ogni cosa con gli elementi decorativi Ital Decor. Rendere la facciata classica o moderna in tempi rapidi con un materiale garantito e duraturo.

Elements for exterior.

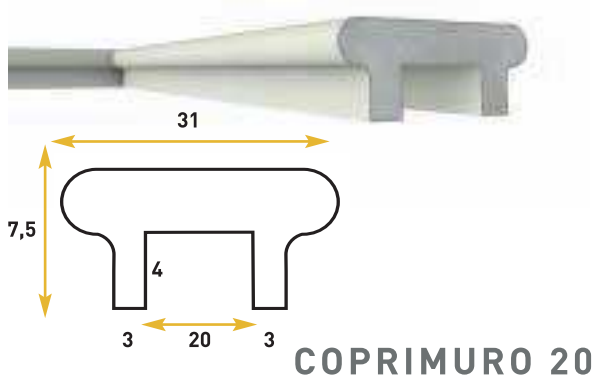
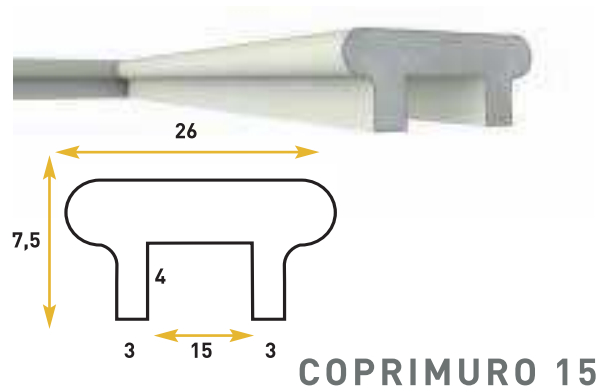
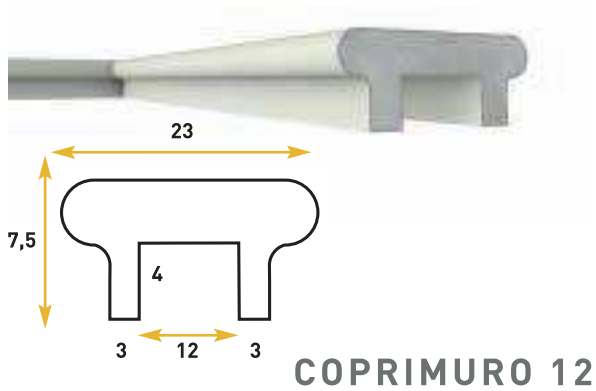
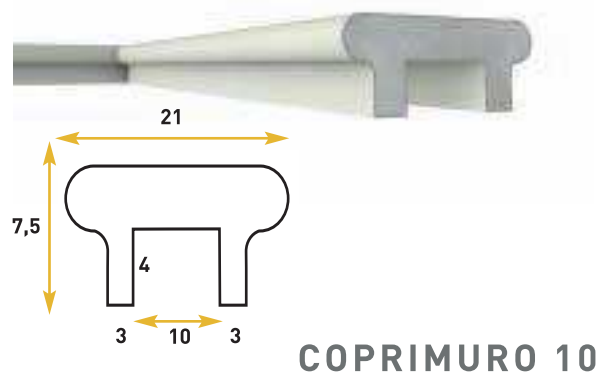
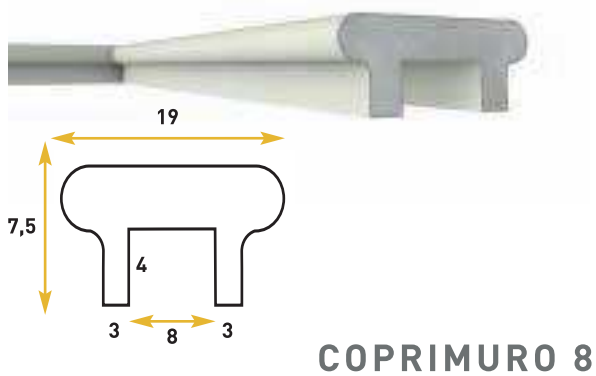

- Le misure sono espresse in centimetri, la lunghezza del coprimuro è di cm 200
- Disponibile in finitura bianca, verniciabili con idropitture elastomeriche
- Le istruzioni di posa e la scheda tecnica sono consultabili a fine catalogo

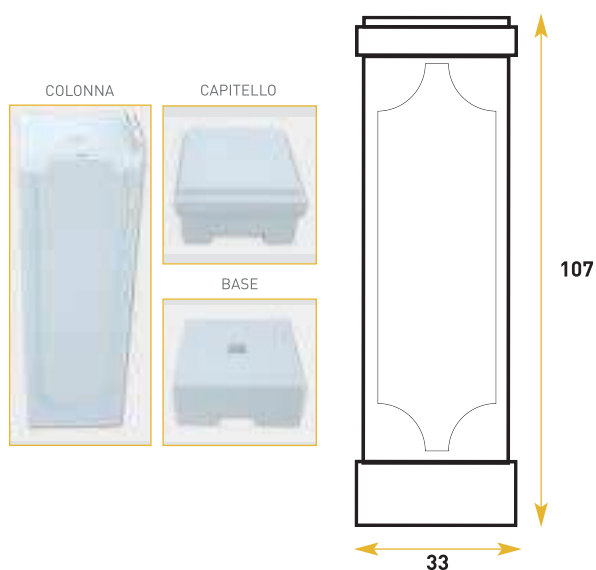
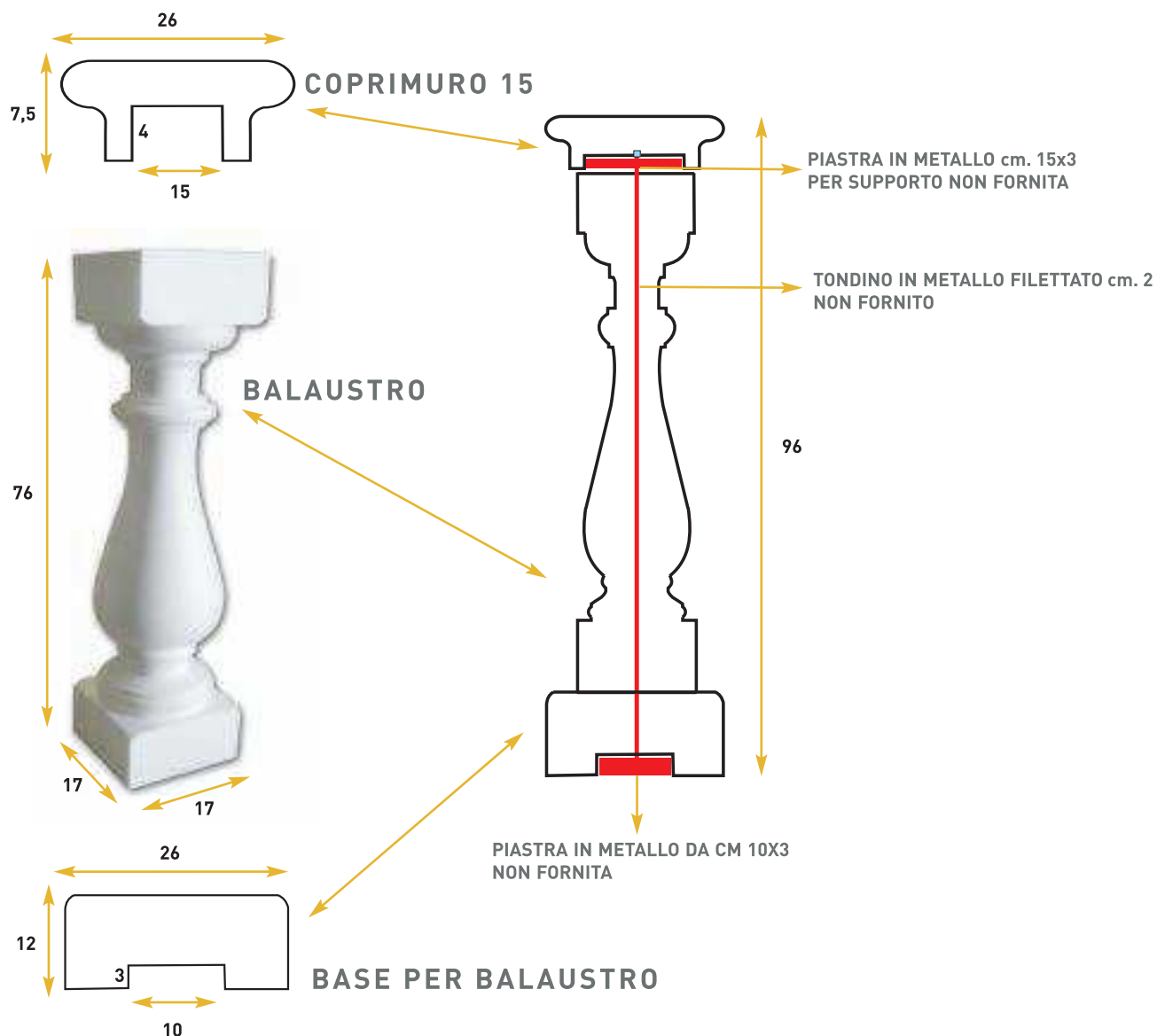

COLONNA QUADRATA PER BALAUSTR

ELEMENTI CHE COMPONGONO LA BALAUSTR

Composto in Eps rivestito con graniglia. Balaustra + Coprimuro 15 + Base per balaustra + Colonna quadrata + Capitello per colonna quadrata + Base per colonna quadrata.

Da comporre in base alle misure occorrenti. Gli elementi vengono forniti separati e con parti vuote dove poter introdurre i supporti necessari come raffigurato negli schemi.

Importante

I supporti in metallo devono essere bloccati tra di loro per risultare quindi fondamentali per la sicurezza e stabilità della balaustra. Altrimenti la balaustra avrebbe una funzione solo ornamentale e non portante.



Composizione completa balustra